



## **Performance Analyser**

# **ClimaCheck PA Pro III *online***

This manual is valid for ClimaCheck systems with part numbers 100 959 - 100 969

## **Installation Manual**

2020-07-10

## Safety Precautions



**Read the instruction manuals for all relevant equipment carefully before starting to use ClimaCheck Performance Analysing systems.**

ClimaCheck PA Pro III is a measuring and analysing system developed to give detailed evaluation of refrigeration, air-conditioning and heat-pump systems in development laboratories, production tests and in the field.

If equipment is used in a way not specified by producer the protection and safety provided may be impaired.

Certifications/licenses are required in most countries for activities related to electrical systems, pressurised systems and systems charged with refrigerants that have environmental impacts and/or flammability.

ClimaCheck products are only intended for use by competent technicians/engineers complying with local requirements for certifications/licenses.

Any work with electricity, pressurised systems or refrigerant involves potential dangers to human health and system integrity if not conducted with caution. Always inspect the equipment for damaged cables or other components before use. For many installations loss of product or disturbances in operation incurs high costs. ClimaCheck assumes no responsibility for injuries or costs that may occur as a result of failures in connection with measurements. The user must evaluate whether an inspection can be carried out without risk of injury and/or damage. Measurements should only be carried out when it can be done under safe working conditions and without risks.

## Table of Contents

Safety Precautions.....	2
1 Introduction .....	5
2 Handling and safety .....	6
3 Required documents and equipment .....	7
4 Modbus Communication between housings.....	8
5 Connection of power measurement .....	9
5.1 Motor configurations .....	9
5.1.1 Part Winding .....	9
5.1.2 Y/D (Star/Delta) .....	9
5.2 Systems with inverter .....	10
5.3 Differential protection .....	10
6 Connection of sensors .....	11
6.1 Mounting of pressure transmitters/transducers .....	11
6.2 Mounting temperature sensors.....	11
6.2.1 Required insulation .....	11
6.2.2 Compensating for changes in temperature sensor cable length .....	12
6.3 1-wire temperature sensors.....	12
7 Extension cables .....	14
8 Commissioning .....	15
8.1 Powered units .....	15
8.2 Communication between PA Pro III and ClimaCheck online .....	15
8.3 Communication between PA Pro III and other units .....	15
8.4 16 .....	
9 ClimaCheck PA Pro III Hardware .....	17
9.1 LED indicators .....	17
9.2 Display.....	18
9.3 Start.....	19
9.4 Menus.....	20
9.5 Monitor .....	20
9.5.1 View all values .....	20
9.5.2 Send interval / Intense send .....	21
9.5.3 Signal level .....	21
9.5.4 Show IP-addresses .....	21
9.5.5 Show IODevices .....	21
9.6 Setup.....	22
9.6.1 Reload configuration .....	22
9.6.2 Reboot .....	22
9.7 Network Setup .....	22
9.7.1 Set network interface .....	22
9.7.2 WiFi connectivity for PC in Online Mode. ....	23
10 Configuration of 1-wire sensors .....	24
10.1 Connecting sensors.....	24
10.2 Replace a 1-wire sensor.....	24
10.3 Clear all 1-wire sensors.....	24
11 Configuration of PA Pro III .....	26
11.1 Change analog input mode (mA/V).....	26
11.2 Change communication mode .....	26
12 Configuration of Power Meter EM24.....	28
12.1 Change CT-ratio configuration.....	28
12.2 Change Modbus address.....	28
13 Configuration of Power Meter EM210 .....	29
13.1 Change CT type configuration .....	29
13.2 Change Modbus address.....	29
14 Configuration of IO module R560 .....	30

14.1	Change Modbus address.....	30
14.2	Change Analog input mode.....	30
15	Troubleshooting.....	31
15.1	Pressure readings.....	31
15.1.1	Required tools and spare parts .....	31
15.1.2	Transmitter type.....	31
15.1.3	Supply voltage .....	31
15.1.4	Pressure signal .....	32
15.2	Temperature readings with PT1000 sensors.....	32
15.2.1	Required tools and spare parts .....	32
15.2.2	Common issues .....	33
15.2.3	Temperature-resistance table .....	33
15.3	Temperature readings with 1-wire sensors .....	33
15.4	Power measurement .....	34
15.4.1	Supply voltage .....	34
15.4.2	Communication .....	34
15.4.3	Measurement .....	34

Note: Areas with red side marking are related to certification and should not be changed without new date here log on changes are kept separately. Current date of changes is 2018-03-16.

# 1 Introduction

ClimaCheck<sup>1</sup> is a measuring and analysing system developed to give detailed evaluation of refrigeration, air-conditioning and heat-pump systems in development laboratories, production tests and in the field.

The method is based on measurements in the refrigeration circuit and does not require any fixed installation of metering equipment in the system. The advantages of easy connection, immediate and detailed information makes the ClimaCheck method superior for evaluating all refrigeration, air-conditioning and heat pump systems.

**An increased focus on energy efficiency can be seen in the [EU Directive 2002/91/Ec on the Energy Performance of Building](#) and several other requirements on energy performance on other markets. This directive requires annual inspections with verifications of energy efficiency of all AC systems with more than 12 kW rated capacity. Measuring with ClimaCheck gives an excellent foundation for performance inspections.**

The ClimaCheck Performance Analysing method allows **complete analysis** of energy performance as well as presenting all information to validate the individual components and their optimization without the requirement of any fixed equipment making it possible to immediately identify and locate any deficiencies in the system. The method was patented in 1986 and has since been used in Sweden and internationally in the Product ETM 1500, ETM 2000, ClimaCheck PA 8:7 and now ClimaCheck PA Pro.

The server based monitoring software is constantly logging the performance of the system and uses the globally accepted equations for refrigerant properties in RefProp established by NIST (National Institute of Standards and Technologies in USA). Anyone with the user name and password can log in to the system from an Internet connected PC as well as have the server send alarms when important parameters fall outside of their specified ranges.

The ClimaCheck method is suitable for almost all compressor-based refrigeration processes. All suction or discharge gas cooled hermetic and semi hermetic compressors can be fully evaluated without any compressor or system specific information. For open compressors the electrical motor efficiency is given as input and for compressors with external cooling of air, water, oil or liquid injection information on the cooling need to be entered to give a full capacity and COP accuracy. For many types of systems data on compressor cooling are well known and necessary parameters are known. ClimaCheck Specialists should be consulted to give advice on non-standard systems.

## 2 Handling and safety

To ensure safe installation and operation the following instructions must be followed carefully:

- The equipment should be powered by either 90 – 264 V AC at 47 – 64 Hz or 120 – 370 V DC. The maximum power consumption of the system is 25 W.
- An easily reachable external switch for breaking power to the installation has to be available.
- Operating temperature range for the equipment is -20 to +50 °C.
- Operating humidity is R.H. 0 – 90 % non-condensing.
- Maximum operating altitude: 2000 m
- The equipment is designed for a maximum of Pollution Degree 2.
- The equipment enclosures have not been tested for UV-resistance and are thus not approved for outdoor use.
- The enclosure must be mounted with at least three sides having a minimum clearance of 10 cm. The front must have a clearance of at least 30 cm.
- Burned out fuses must be replaced in accordance to the table below. Use only UL/CSA approved fuses.

Marking on fuse holder	Fuse type
L	T 1 A L, 250 V
L1	T 500 mA L, 250 V
L2	T 500 mA L, 250 V
L3	T 500 mA L, 250 V

- See section 5 for important safety instructions when connecting the power measurement.
- For all electrical wires not included with the equipment, use UL1569 AWG20 or better. Not that special considerations should be taken for the wiring of the power meters, see section 5.
- The standard enclosure is marked with protection class IP55, but the protection of the final installation may be lower depending on several factors. ClimaCheck do not guarantee a certain protection class.
- If the instructions in this section and the rest of the manual are not observed, the protection provided by the equipment may be impaired.

### **3 Required documents and equipment**

In addition to this instruction a number of documents and equipment is required in order to successfully complete the installation:

- Flow chart of the system with sensor placement, supplied with the attached configuration document.
- Wiring diagram of the system, supplied with the attached configuration document.
- Small flathead screwdriver 2.5 x 0.5 mm.
- Aluminium tape.
- Insulation tape.
- A number of standard tools depending on the nature of the installation.

## 4 Modbus Communication between housings

Depending on system solution, the ClimaCheck system can be divided over several housings with the PA Pro/Gateway in the main housing and R560 units and Power meters in satellite housings. A 3 lead (Modbus +,- and gnd) or 5 lead (Modbus +,-,gnd and 24VDC supply) cable is installed between all satellites and the main housing. See wiring diagrams for details.

When connecting satellite housings, or any other unit to the Modbus terminals, follow the sequence below:

1. Disconnect power supply from all housings/units
2. Connect the 3- or 5-lead communication cable between the housings /units
3. Connect power supply to satellite housings and external units
4. Connect power to main housing
5. Make sure system connects and data is sent to the ClimaCheck server.

External units and satellite housings that are disconnected when the PA Pro/Gateway is booting up will be deactivated. Deactivated units are activated again once every hour or after a reboot of the PA Pro/Gateway.



## 5 Connection of power measurement

### **Important!**



**Improper use of ClimaCheck power meters may cause high voltage build up that can be dangerous both for equipment and operators. Adhere to the practices below to avoid this:**

- **Always connect the CTs to the power meter before they are attached around a live wire.**
- **Always remove the CTs from the live wire before the cables to the power meter are disconnected.**
- **Incorrect connection of voltage between phase and neutral will damage the equipment.**
- **Never use the CTs on uninsulated wires or rails.**

In addition, follow the steps below to assure proper power and energy readings:

- It is important to only measure the power to the compressor. Make sure the measurement is done after the point where circulation pumps and fans are connected.
- Make sure that the voltage and current for each phase corresponds with the markings on the measuring equipment and that the arrow on the current clamps are pointing in the direction of the current.
- Make sure that the CTs are completely closed and that the contact areas are clean.
- Check that the connections are correct by reading the voltage, current and power on the display of the power meter. If you find a problem remove the clamps and attach L1 followed by a control and the repeat the process for L2 and L3.

### **5.1 Motor configurations**

Power measurements require good understanding of the electrical layout of the plant.

It is for example necessary to identify if a three-phase motor is part winding or Y/D (Star/Delta) and connect accordingly.

#### **5.1.1 Part Winding**

Part winding means that the motor has two separate windings and the total current to these should be measured. This can be done in several ways depending on the physical restrictions of cables and CTs.

- Preferred choice is to measure before the contactors where the total current runs through one lead. This can sometimes be physically impossible.
- One alternative is to put clamps around both L1 cables after the contactor or in the connection box on the compressor if this can be done. This is repeated for L2 and L3.
- It is possible to measure with 6 clamps i.e. 2 in parallel to the instrument per phase.
- If there is no way to connect around the total current an acceptable approximation can be achieved by measuring on one of the contactors (the one with largest power draw is preferred) and adjusting the power scale in the ClimaCheck software Input tab. The ratios are typically 50/50 or 60/40 and can be deduced by moving the clamp back and forth.

#### **5.1.2 Y/D (Star/Delta)**

Motor with Y/D start should preferably be measured before supply is split between the three contactors this normally consist of e.g. at L1, L2 and L3.

If measured after the split to K1 and K2/K3 both leads should be measured.

After the "Run" contactor K3 and the split to "Start" contactor K2 the cables to the motor will be connected to different phases depending on position of K2 and K3.

If measured at motor correct cables must be matched so total L1, L2 respectively L3 feed is measured but the reading will be incorrect during start when K2 is activated.

In picture below:

L1 is feeding U and Z

L2 is feeding V and X

L3 is feeding W and Y

If designation of poles is unknown the pairs can be identified by measuring voltage between poles matching pairs will show zero voltage difference.

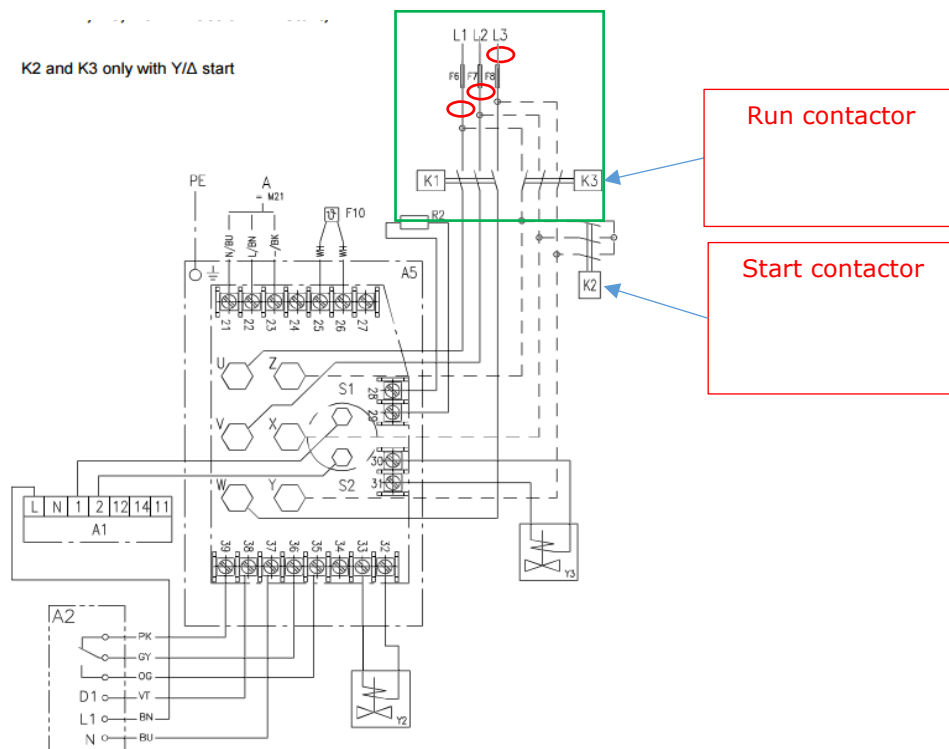

Figure 1 - Y/D (Star/Delta)

## 5.2 Systems with inverter

If inverters are used it is normally necessary to measure before inverter and use a loss factor of typically 3-6% to compensate for the heat loss. Ensure that i.e. fans do not consume power from the same feed. If so an offset can be added in the input tab

## 5.3 Differential protection

Differential protection is used to improve the security of the installation and will cut the supply if any current is drawn outside the "protected loop". As the EM210 is powered by the voltage line L1 and L2, differential protection must be taken into account when connecting.

## 6 Connection of sensors

Sensors should be placed in accordance with the supplied flowchart and connected to the system as shown on the supplied wiring diagram. All sensors should be checked against room temperature and atmosphere pressure before being attached. Check section 15 for troubleshooting.

### 6.1 Mounting of pressure transmitters/transducers

Pressure should be registered as close as possible to the compressor inlet and outlet. Pressure drop between sensor and compressor will affect the accuracy.

### 6.2 Mounting temperature sensors

Temperature sensors may be mounted on the outside of piping with the ClimaCheck method due to the inherent low sensitivity to temperature errors. This is a critical advantage compared to traditional methods but should not be taken as an excuse to not follow the recommended procedures below.

Temperature sensors should be mounted:

- 10-20 cm from the compressor, flanges, valves or other objects that can act change the surface temperature compared to the inner temperature of the tube.
- Maximum contact should be ensured by:
  - Removal of any insulation and paint on the tube.
  - When mounted in pockets the sensor must be securely pressed against the wall of the pocket.
  - Heat transfer paste should always be used for surface and "pocket" mounted sensors.
- Aluminium tape should always be used for surface mounting.
- Insulation should be carefully done and diffusion tight if the surface/object is cold. The openings of dip tubes/pockets should be sealed/covered with insulation.
- In the case of PT1000 sensors with red four lead cables, the pairs with the same colour should be attached together to the terminals.



**Figure 2 - Apply sensors with heat transfer compound, Aluminium and insulation**

#### 6.2.1 Required insulation

Many factors have an impact on required insulation to achieve good accuracy:

- dT to ambient  
High dT obviously increases the error from poor insulation.
- Radiation from surrounding hot/cold surfaces.

- Material type in tube  
Good heat transfer decreases the error caused by the wall from best to worse copper - iron - stainless - plastic.
- Material thickness in tube  
Dimension, pressure and material define thickness thicker tube wall increase need of insulation.
- Condensation  
It is important to avoid condensation on or near sensor as this will have a significant impact on temperature reading.
- Ice formation  
If ice is allowed to form around sensors (condensation on cold tubes) this creates an insulation.

### Importance of accuracy

A service check can allow a higher tolerance for errors than an inspection to validate that performance is according to contract.

Note that even if temperatures on secondary side do not have any impact on capacity and COP of refrigeration process, they will, if nominal data is taken from manufacturers, strongly impact these reference data.

We advise common sense to be applied, with special attention to discharge and suction line sensor on the refrigerant side due to high dT and risk of condensation.

For best accuracy, remove dirt, paint and corrosion, and avoid pushing sensors inside existing insulation - cut a hole in insulation instead. Always use heat transfer paste and aluminium tape to make insulation on cold tubes so that condensation or ice formation cannot take place on sensor.

Smaller size copper tube	minimum 60 mm x 8 mm tight insulation pressed against tube (thickness 8 mm or 3 turns of insulation tape)
Larger size CU (> 35 mm/1.5")	minimum 100 mm x 8 mm tight insulation pressed against tube (thickness 8 mm or 3 turns of insulation tape)
Steel/plastic/stainless piping	minimum 15 cm x 8 mm insulation

### 6.2.2 Compensating for changes in temperature sensor cable length

No configuration has to be made when using black 1-wire sensors and when using the entire white 5 m cable or the entire red 10 m cable of a PT1000 temperature sensor. If a PT1000 cable is shortened or lengthened the change in resistance needs to be compensated for. The standard temperature offset (0.35 K) needs to be **increased for a longer cable** or **decreased for a shorter cable**. The white cable got a resistance of 0.07 K/m and the red cable 0.035 K/m (using all four leads in pairs).

Fill in the offset for each changed PT1000 in the Configuration document and send to ClimaCheck support.

### 6.3 1-wire temperature sensors

1-Wire temperature sensors are bus sensors and the measured values are not affected by the resistance in the cable between the master (PA Pro III) and the slave (sensor). However, there are some limitations on how to wire these sensors. The preferred topology can be seen in Figure 3.

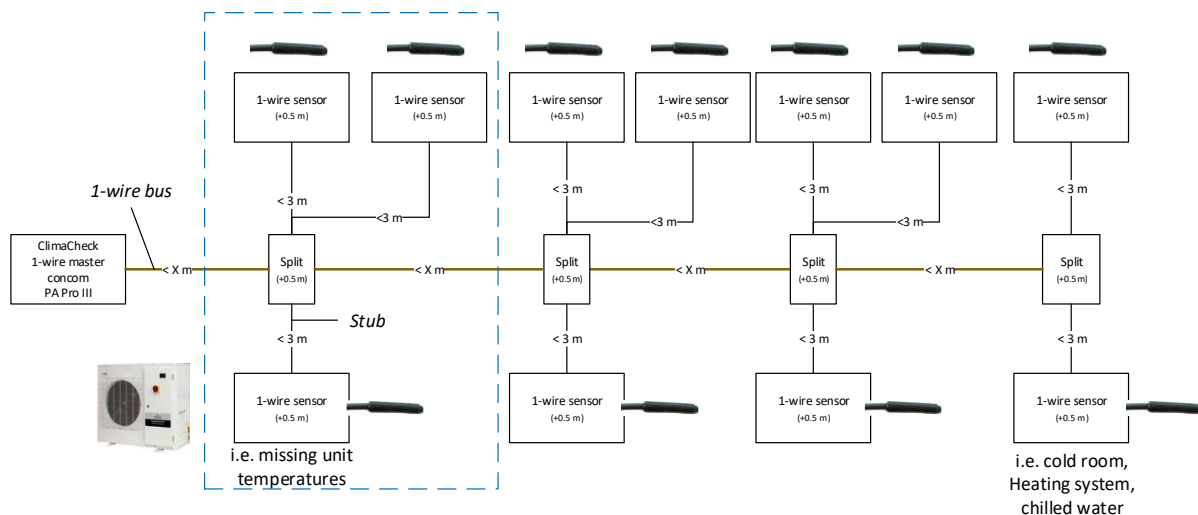

**Figure 3 - 1-wire preferred topology**

The PA Pro is connected at one end of the 1-wire bus and each sensor is connected to the bus with branches or “stubs” where each stub is less than 3m. The PA Pro can handle a total of 16 sensors and a total “weight” of 65 m. The weight is the length of all cables + 0.5m per sensor + 0.5m per split.

Weight = total cable length + 0.5\*sensor + 0.5\*split

*Example: 3 sensors on 2 meter stubs that is located 5 meters from the PA Pro with 1 split has a total weight of  $0.5*3+(2*3+5)+0.5*1=14$ .*

Do not run signal wires in parallel with power cables.

Check section 10 for configuration of 1-wire sensors.

## 7 Extension cables

When extending cables on ClimaCheck sensors, care needs to be taken to choose the correct type of extension. Below are the recommended cable types for each sensor.

- Temperature sensor, PT1000: 0.14 mm<sup>2</sup> 2-lead cable. The PT1000 is a resistance thermometer and the resistance in the cable will affect the readings. The standard 5 and 10m ClimaCheck PT1000 sensors have an offset of 0.35 K which is configured in the PA Pro III. Any changes in the cable length (extending or shortening) needs to be noted and reported to ClimaCheck Support so that the offset is adjusted. When extending the cable, the resistance of the extension cable needs to be noted and reported to ClimaCheck Support.
- Temperature sensor, 1wire: 0.5 mm<sup>2</sup> twisted shielded cable. The 1wire is a digital sensor and the cable length does not result in an offset in the value. Check Section 6.3 for more information about extending the 1wire sensors.
- Pressure: 0.5 mm<sup>2</sup>. When using cables longer than 20m, it is good to evaluate if 4-20mA sensors should be used instead of the standard 1-5V sensors.
- CT connected to EM24: Consult the separate installation instructions depending on CT type and cable length
- CT connected to EM210: 0.5 mm<sup>2</sup> 2-lead cable
- Rogowski connect to EM210: 0.14 mm<sup>2</sup> twisted shielded cable
- Voltage cable to power meter: Check local regulations about fuse and cable size.
- Modbus RS485 (cable between different housings): 0.5 mm<sup>2</sup> twisted shielded cable
- 24VDC between housings: 0.5 mm<sup>2</sup> 2-lead cable

## 8 Commissioning

Follow the below points to test and verify the installation and the sensors. For troubleshooting, refer to Section 15.

### 8.1 Powered units

The PA Pro III's display will turn on when the unit is powered. If the display is not on, make sure that auxiliary power is connected to the fuse holder, the fuse holder has a working fuse, and the PA Pro III is receiving 24VDC. Check the wiring diagram for more details.

The power meters' display will turn on when they are powered. If the displays are not on, make sure they are receiving power. The EM210 is powered by the 3-phase voltage measurement (phase L2-L3 power the unit). The EM24 can be powered by 24VDC or auxiliary power. Check the wiring diagram for more details.

The R560 has LED lights which will blink when the unit is powered. If the lights are not blinking, double check from different viewing angles, and make sure that auxiliary power is connected to the fuse holder, the fuse holder has a working fuse, and the R560 is receiving 24VDC. Check the wiring diagram for more details.

### 8.2 Communication between PA Pro III and ClimaCheck online

Log in to ClimaCheck online ([online.climacheck.com](http://online.climacheck.com)) with the provided username and password. Click on "Select circuit/process/plant" and click on the relevant process. Make sure "Time for last received data" shows the current time (or a few minutes early).

If the data are not updated and the "Time for last received data" is red, then there is no communication with ClimaCheck online.

Make sure that the correct network interface is selected. This can be changed from the PA Pro III menu. Check Section 9.7.1 for more details.

If using GPRS, make sure the SIM card is inserted, the antenna is connected, and the antenna has good signal. The signal level can be checked from the PA Pro III menu. Check Section 9.5.3 for more information.

If the SIM card type/operator has been changed from what it has been agreed on delivery, the APN needs to be reconfigured. Contact ClimaCheck Support for more help.

If using LAN, make sure the Ethernet cable is inserted on both ends. If network configuration details have been changed from what it has been agreed on delivery, network settings need to be reconfigured. Contact ClimaCheck Support for more help.

If the PA Pro III is connected to the network, but no data is reaching ClimaCheck online, make sure all necessary ports are open:

- UDP port 2049 to [online.climacheck.com](http://online.climacheck.com): Send data as a text string (ID, Timestamp, data1, data2, ...) to ClimaCheck online
- TCP port 80 to [integration.climacheck.com](http://integration.climacheck.com): Fetch configuration and analysed values
- TCP port 5001 to [online.climacheck.com](http://online.climacheck.com): Firmware and application updates and troubleshooting.

### 8.3 Communication between PA Pro III and other units

Communication between PA Pro III and other units (R560, power meters, Modbus sensors) are tested before shipment. Make sure that values from each unit is shown on the PA Pro III display. Check Section 9.5.1 for more information.

If connecting the PA Pro III housing to an additional housing, make sure that the 5 terminals in each housing is connected to each other correctly. Check the numbering on each terminal and the provided wiring diagram. Make sure the correct cable type is being used to connect the housings. More information in Section 7.

## 8.4 Sensor readings

Make sure that the temperature, pressure, and power readings are correct. If there are sensors on-site, check the controller for readings and compare to the values from the ClimaCheck system.

For temperature sensors, make sure that values are reasonable when system is running:

- Discharge temperature is highest among all temperatures
- Secondary cold side inlet is higher than secondary cold side outlet
- Suction temperature is lower than secondary cold side inlet
- Secondary warm side outlet is higher than secondary warm side inlet
- Condenser refrigerant out is higher than secondary warm side inlet

For pressure sensors, make sure the correct pressure range sensor is used. Check the configuration document for more information. When system is running the high pressure reading should be higher than the low pressure reading. Compare the evaporation and condensing temperatures to the ones provided from the controller or compare the pressure readings to on-site sensors. Note that the pressure values are shown in kPa(a) on the PA Pro III display and in Bar(g) on the ClimaCheck online flowchart.

For the power meter, compare the ClimaCheck values to the on-site values from a controller and make sure that the power factor shown from ClimaCheck is reasonable. Refer to Section 15.4 for step by step instructions on values to check.

If measuring more than one chiller/system, make sure that the power values correspond to the same chiller as the temperature/pressure values.



## 9 ClimaCheck PA Pro III Hardware



This section describes the details of the ClimaCheck PA Pro III hardware.

### 9.1 LED indicators



The ClimaCheck PA Pro III has 4 LED indicators:

- A: ClimaCheck online
- B: 1-wire / Modbus
- S1: Status
- S2: Modem









The A LED indicates the status on contact with ClimaCheck online server.

A Led (CC Online)	Status
 900ms on, 900ms off	Connection with ClimaCheck Online OK (Normal operation with internet connection)
Off	No connection with ClimaCheck Online (Normal operation without internet connection)
 Fast blinking	Unsuccessful to send data to ClimaCheck Online

The B LED indicates the status of 1-wire and Modbus communication.

B LED (1W/Modbus)	Status
 900ms on, 900ms off	All configured Modbus and 1-wire units OK (Normal operation)
 400ms on, 400ms off	Modbus communication error
 Continuous on, off	1-wire communication error

The S1 LED indicates the status on the PA Pro program.

S1 LED (Status)	Status
 500ms on, 500ms off	PA Pro application running OK (Normal operation)
 1500ms on, 500ms off	PA Pro application running OK, while charging the internal back-up battery.
 500ms on, 500ms off	PA Pro application running OK, while connected to ClimaCheck software (Normal operation, while connected to software)
 Fast blinking	The unit has been forced into recovery mode with the use of the system switch. The application is not executing.
 Fastest blinking	The unit is initializing, preparing to start the application.
 75ms on, 925ms off	Execution speed is different from full-speed.
 Fast blinking	A runtime error has been detected in the program, contact ClimaCheck support
 Alternating Fast/Slow	The unit has lost its firmware, contact ClimaCheck support

The S2 LED indicates the modem status.

Communication status is showed as an icon in the display and with the S2 LED, see table below.

S2 LED (Modem)	Status
Off	The GSM module is turned off.
● 600ms on, 600ms off	No SIM card inserted or no PIN code entered, or network search in progress, or ongoing user authentication, or network logon in progress.
● Single 75ms on, 3s off	Logged to the network, no call in progress.
● Double 75ms on 3s Off	A GPRS session is active. Bars indicate signal strength
● Flashing	Indicates GPRS data transfer.

## 9.2 Display

On the front of the PA Pro III unit a 240x160 pixel, white on blue, LCD display with built in resistive touch sensing can be found.

The top part of the display is reserved for a status bar showing status of the different communication interfaces as well as the time and the battery status, see Figure 4.













The main part of the display is reserved for internal ClimaCheck PA Pro III application showing menus and data. The lower and right side is used for virtual buttons to navigate.



Figure 4 - Display with status bar and virtual buttons

The table below describes the icons on the status bar.

Icon	Status
<b>GSM Status</b>	
	GSM off
	GSM on
	Signal strength
<b>GSM network type</b>	
	2G
	3G
<b>Mobile network status</b>	
	Network connected
	Roaming
	Network connected while roaming

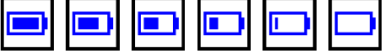
Call Status	
	Call active (not used in ClimaCheck application)
Wi-Fi Status	
	Wi-Fi Off
	Wi-Fi on
	Wi-Fi signal level
LAN Status	
	LAN off
	LAN on (disconnected)
	LAN connected
RTCU Gateway Status	
	RTCU Gateway not enabled
	RTCU Gateway enabled
	RTCU Gateway connected
USB status	
	USB host supported
Bluetooth status	
	Bluetooth off
	Bluetooth on
Power status	
	Battery level (animated while charging)

### 9.3 Start

ClimaCheck PA Pro III starts directly when it is connected to the power supply. It has two main connection modes, Online Mode and PC Mode. PC Mode is the default setting when logging data to the PC Software with ClimaCheck Onsite and Online Mode is default setting in permanent ClimaCheck Online installations.

After half a minute, the display shows **Connect to PC?** Press **No** to be able to connect to the internet and send data to ClimaCheck online. If nothing is pressed, the PA Pro III will continue to the default connection mode.

Connection to the internet is possible by GPRS modem (with a SIM card), Ethernet, or Wifi. To change the network interface, follow section 9.7.1

After around half a minute, the display shows **ClimaCheck PA Pro III**, the 6 digit ID, the application version, and the connection mode. The unit can now be used.

The unit can be turned off by disconnecting the power. The internal backup battery allows for a safe shut down.

## 9.4 Menus

There are 8 push buttons on the PA Pro touch screen. To open the main menu, press **Esc**. To open a sub menu, press **SEL**. To choose a function or confirm a configuration, press **OK**. To go back, press **ESC**. The menu structure is shown in Figure 5.

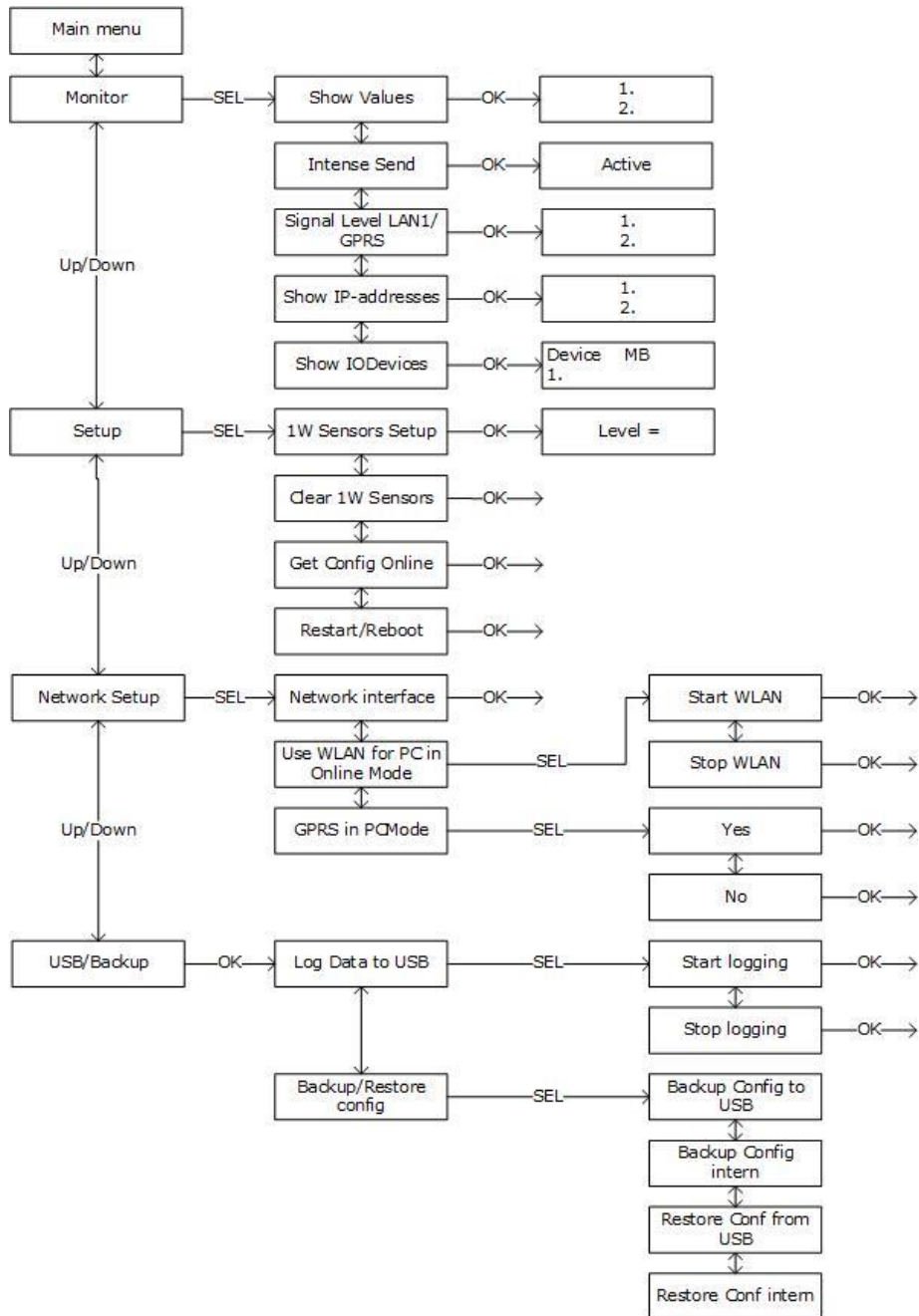

Figure 5 - Menu structure

## 9.5 Monitor

All values from sensors and power meters can be seen under the Monitor menu. From the Monitor menu, the send interval to ClimaCheck online can also, temporarily, be changed.

### 9.5.1 View all values

To view all values:

- Press ESC to enter the Main menu
- Press Down until "Monitor" is shown in the display
- Press SEL to enter Monitor menu
- "Show values" appears in the display
- Press OK

Values are shown with a sensor/value number, a comment/description, the sensor reading, and a unit. Press Up/Down to step through the list of values.

### 9.5.2 Send interval / Intense send

Data is sent to the ClimaCheck online server once every minute when the compressor is on and every 5 minutes when the compressor is off. To activate "intense send" and send data every 15 seconds:

- Press ESC to enter the Main menu
- Press Down until "Monitor" is shown in the display
- Press SEL to enter Monitor menu
- Press down until "Intense send" is shown in the display
- Press OK
- "Intense Send Active" appears

Intense send is automatically swished off after 15 minutes.

### 9.5.3 Signal level

When using the PA Pro III with GRPS modem or wireless WLAN, it is possible to check the signal level.

- Press ESC to enter the Main menu
- Press Down until "Monitor" is shown in the display
- Press SEL to enter Monitor menu
- Press down until "Signal Level" is shown in the display
- Press OK

### 9.5.4 Show IP-addresses

To show what IP-addresses the PA Pro III uses on LAN, WiFi and GPRS connections:

- Press ESC to enter the Main menu
- Press Down until "Monitor" appears in the display
- Press SEL to enter Monitor menu
- Press Down until "Show IP-addresses" is showed in the display
- Press OK

IP-addresses for all network interfaces are presented. To change communication settings, see Section 9.7.1.

### 9.5.5 Show IODevices

To show status and address for all configured Modbus units:

- Press ESC to enter the Main menu
- Press Down until "Monitor" appears in the display
- Press SEL to enter Monitor menu
- Press Down until "Show IODevices" appears in the display
- Press OK

Device name, Modbus address and status are displayed. Status is OK when communication is working and Error if the unit can't connect to the IODevice. After a number of failed attempts, the device is disabled and get Status Disabl. The unit will enable the devices again once every hour to try to restore communication. The most common devices are listed in the table below.

Device	Description
IAIO	Internal Analog Input and Output on the PA Pro III
R560	ClimaCheck R560 analog input module
EM24	Power meter
EM210	Power meter
1W	Internal 1-Wire module

## 9.6 Setup

All configuration of the ClimaCheck PA Pro III unit, except 1-wire sensors and network configuration, can be done on the ClimaCheck Online server. Any changes to Modbus addresses or external units such as energy meters or IO modules can be done on the ClimaCheck Online server and then downloaded to the unit. If the unit has an internet connection it will try to contact the server every 6 hours to check for commands to Reload configuration from the server or to Restart.

To set up 1-wire sensors, check Section 6.3.

### 9.6.1 Reload configuration

It is possible to force a reload of the configuration through the hardware. Make sure the unit has internet connection and then:

- Press ESC to enter the Main menu
- Press Down until "Setup" is showed in the display
- Press SEL to enter setup menu
- Press Down until "Get Config Online" is showed in the display
- Press OK to load configuration from CC Online server
- "Waite for config, Loading.." appears in the display

After a few seconds, when the configuration has been updated, the unit will go back to the initial view.

### 9.6.2 Reboot

It is possible to force a reboot of the unit through the hardware:

- Press ESC to enter the Main menu
- Press Down until "Setup" is showed in the display
- Press SEL to enter setup menu
- Press Down until "Restart/Reboot" is showed in the display
- Press OK

The unit will reboot.

## 9.7 Network Setup

The Network Setup menu allows to choose the way the PA Pro III will connect to the internet, as well as allow the PA Pro III to temporarily create a Wifi network where the PC software can connect to.

### 9.7.1 Set network interface

Network interface used by the PA Pro III to communicate with internet (ClimaCheck Online server) can be set on the network interface menu. To enter it

- Press ESC to enter the Main menu
- Press down until "Network Setup" appears in the display
- Press SEL to enter Network Setup menu
- "Network Interface" appears in the display
- Press SEL

The PA Pro III will change view, at the top of the page the current selection is displayed as (Active XXXX) where XXXX is GPRS, LAN, WiFi, non or DIP. Below 6 options are listed:

Network	Description
GPRS	Use the built-in modem
LAN	Use the LAN connection to connect through a local network
LAN2	Not present
WiFi	Use the Wi-Fi connection.
No network (Flight mode)	Unit is not connected to internet, all network interfaces (including modem/GPRS) are switched off. Only USB connection to a local computer is possible.
Use DIP-Switch	Changes network dependant on the DIP-switch setting, see section 11.2

- Choose network interface by pressing directly on the desired interface.
- Press OK to confirm

### 9.7.2 WiFi connectivity for PC in Online Mode.

By default, the WiFi access point in the PA Pro III is deactivated in Online mode. To activate it without changing the connection mode or rebooting the system follow the steps below.

- Press ESC to enter the Main menu
- Press down until "Network Setup" appears in the display
- Press SEL to enter Network Setup menu
- Press Down until "Use WiFi for PC in Online Mode" appears in the display
- Press SEL to enter the menu
- Press Yes, and then confirm with OK,
- Press ESC until the start screen shows

A PC can now connect to the PA Pro III and log data over WiFi simultaneously as data is sent to ClimaCheck Online. To deactivate the access point functionality again follow the steps below.

- Press ESC to enter the Main menu
- Press down until "Network Setup" appears in the display
- Press SEL to enter Network Setup menu
- Press Down until "Use WiFi for PC in Online Mode" appears in the display
- Press SEL to enter the menu
- Press No, and then confirm with OK,
- Press OK. "WiFi OFF" appears

The WiFi connection is switched off if the unit is rebooted and starts in Online Mode. See section 9.3 for more information about the Connection modes.

## 10 Configuration of 1-wire sensors

Each 1-wire sensor has a unique ID to identify it on the 1-wire bus and each sensor needs to be configured/connected in the PA Pro.

The provided 1-wire sensors are already configured and labelled. To add or replace a non-configured 1-wire sensor, follow the sections below.

Check section 15.3, for troubleshooting.

### 10.1 Connecting sensors

The sensors need to be connected and configured **one at a time**. Use the following sequence to setup and connect the sensors:

- Press ESC to enter the Main menu
- Press Down until "Setup" is shown in the display
- Press SEL to enter setup menu
- "1W Sensor Setup" appears in the display
- Press OK to start setup

If this is the first setup, "T1 Sensor not conf" appears in the display. If sensors are already configured, they will be listed.

- With the up and down arrows go to the position you want to save a sensor to
- Press SEL
- "TX NEW=xxxxxx OK" is shown in the display, where TX is the position and xxxxxx is the ID number of the sensor
- Confirm with OK, "S-RID Saved" appears for 2 seconds
- Temperature reading and ID appears in the display "TX=XX.X ID=xxxxxx"
- Press up/down to continue with the next sensor or ESC 4 times to go back to the main menu.

If "No new s-r found" appears while setting up a new sensor, the PA Pro cannot find any sensor on the bus that is not already configured. Check the connection and make sure the sensor has not been configured already.

### 10.2 Replace a 1-wire sensor

To replace a 1-wire sensor:

- Disconnect old sensor
- Press ESC to enter the Main menu
- Press Down until "Setup" is shown in the display
- Press SEL to enter setup menu
- "1W Sensor Setup" appears in the display
- Press OK
- Select the sensor number in the list, it will say "Sensor missing".
- Connect new sensor and press SEL,
- "Tx NEW=xxxxxx OK" is shown in the display
- Confirm with OK, "S-RID Saved" appears for 2 seconds
- Temperature reading and ID appears in the display "TX=XX.X ID=xxxxxx"
- Press ESC 4 times to go back to the main menu.

### 10.3 Clear all 1-wire sensors

To clear all configured 1-wire sensors:

- Press ESC to enter the Main menu
- Press Down until "Setup" is shown in the display
- Press SEL to enter setup menu
- Press down until "Clear 1W Sensors" is shown in the display
- Press OK



- “Clearing..” appears and then you’re back in the setup menu

This will clear all 1-wire sensors including any preconfigured 1-wire sensors. You can now connect the sensors again, see section 10.1.

## 11 Configuration of PA Pro III

The chapter describes the DIP-switches on the ClimaCheck PA Pro III and how to configure them. In most cases the unit will be delivered pre-configured to fit the system, but changes in the setup compared to the order may cause a need for change of these settings. For a full description please refer to the hardware manual.

### 11.1 Change analog input mode (mA/V)

To change the analog inputs on the PA Pro III between current and voltage input, DIP-switches on the back side of the unit are used, see Figure 6.

The red DIP-switch block to the right controls analog input 1 to 4 where OFF means voltage input (0-10V) and ON means current input (0-20mA).

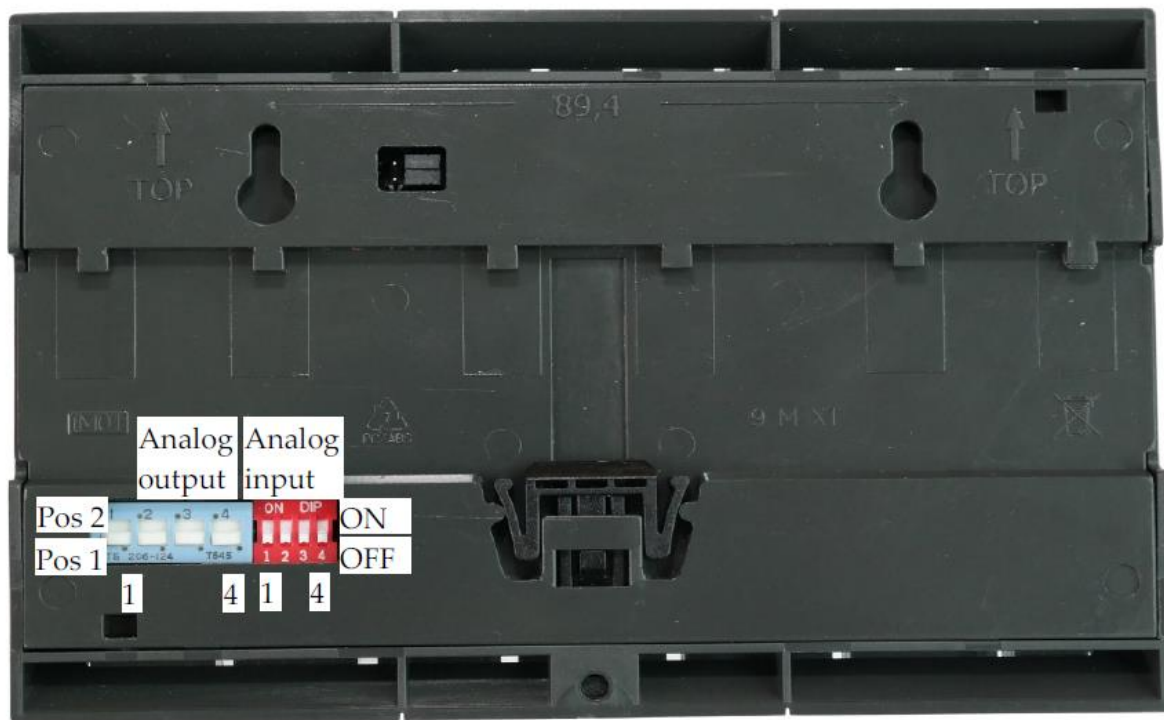
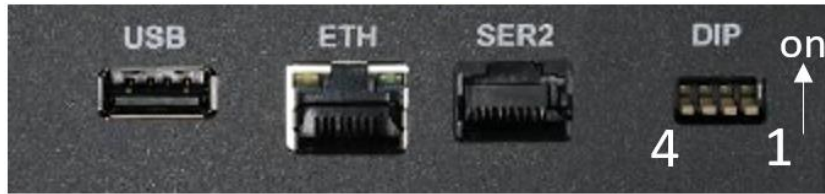

Figure 6 - Back side view

Pin	Position	Function
1	ON	Analog input 1 as current input
	OFF	Analog input 1 as voltage input
2	ON	Analog input 2 as current input
	OFF	Analog input 2 as voltage input
3	ON	Analog input 3 as current input
	OFF	Analog input 3 as voltage input
4	ON	Analog input 4 as current input
	OFF	Analog input 4 as voltage input

### 11.2 Change communication mode

To select communication mode between LAN, WLAN and mobile, DIP-switches 1 and 2 on the top left side are used, see Figure 7.



**Figure 7 - DIP-switches for communication**

DIP 1	DIP 2	Communication mode
OFF	OFF	Mobile / GSM
ON	OFF	LAN
ON	ON	WLAN

Reboot the unit for changes to take effect, see section 9.6.2.

## 12 Configuration of Power Meter EM24

This section explains how to change the most common settings on the EM24. In most cases the power meters will be delivered pre-configured to fit the system, but changes in the setup compared to the order may cause a need for change of these settings.

### 12.1 Change CT-ratio configuration

The EM24 is normally pre-configured for the current transformers to be used, but change of plans may require the adjustment of the current ratio. The ratio is most often described as a ratio, for example 300:5 A. To get the correct value divide the first number by the second, for example  $300/5 = 60$ .

- Put the knob in position 1 to enable programming.
- Push in the joystick for three seconds.
- Enter the password by pushing up/down. Default setting is 0.
- Push in to enter the password.
- Push right five times to the menu section "Ct rAtio".
- Push in to change the setting (PrG is displayed).
- Push right/left to toggle between different size ranges for the CT-ratio and up/down to set the exact value. A small "k" to the left of the value denotes a multiplier of 1000.
- Push in to save the setting (PrG disappears).
- Push left six times to the menu section "End".
- Push in to end the programming.
- Put the knob back into position "locked".

### 12.2 Change Modbus address

In a system with more than one power meter EM24 the units have different addresses for the central unit to distinguish among them. This address is normally correctly set when delivered but can sometimes need to be changed.

- Put the knob in position 1 to enable programming.
- Push in the joystick for three seconds.
- Enter the password by pushing up/down. Default setting is 0.
- Push in to enter the password.
- Push left three times to the menu section "AddrESS".
- Push in to change the setting (PrG is displayed).
- Push up to change address to the desired number.
- Push in to save the setting. The display will show "bAudrAtE".
- Push up and then right twice to the menu section "End".
- Push in to end the programming.
- Put the knob back into position "locked".

## 13 Configuration of Power Meter EM210

This section explains how to change the most common settings on the EM210. In most cases the power meters will be delivered pre-configured to fit the system, but changes in the setup compared to the order may cause a need for change of these settings.

### 13.1 Change CT type configuration

The EM210 is normally pre-configured for the current transformers to be used, but change of plans may require the adjustment of the current transformer type. There are 2 types of current transformers compatible with EM210: CT with 333mV output and Rogowski coils.

- Open the parameter menu by holding the Return button for 3 seconds

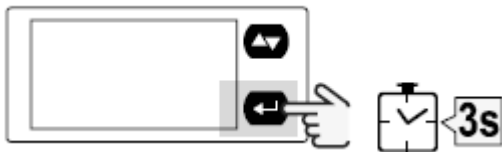

- Select the password by pushing up/down. Default setting is 0.
- Hold the Return button for 3 seconds to enter the password
- Press the up/down button 3 times to the menu "SEnSOR"
- Press the Return button to change the settings. (C is displayed)
- Use the up/down button to select "roG" for Rogowski and "Ct" for CT with 333mV output
- Hold the Return button for 3 seconds to enter the CT type
- Press the up/down button 2 times to the menu "Ct Pr in"
- Press the Return button to change the settings. (C is displayed)
- Use the up/down button to select the primary current of the CT. When C is displayed next to the number, the up/down button will increase the number. To decrease the number, press on the Return button. Now -C is displayed next to the number and pressing the up/down button will decrease the number. When using Rogowski coils, select 4.00K.
- Hold the Return button for 3 seconds to enter the primary current
- Push the up/down button 11 times to the menu "End".
- Push the return button to end the programming.

### 13.2 Change Modbus address

In a system with more than one power meter EM210 the units have different addresses for the central unit to distinguish among them. This address is normally correctly set when delivered but can sometimes need to be changed.

- Open the parameter menu by holding the Return button for 3 seconds

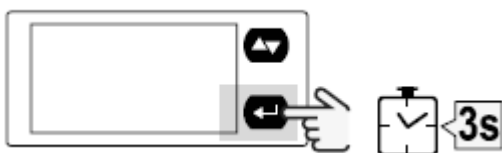

- Select the password by pushing up/down. Default setting is 0.
- Hold the Return button for 3 seconds to enter the password
- Press the up/down button 10 times to the menu "Add"
- Press the Return button to change the settings. (C is displayed)
- Use the up/down button to select the address. When C is displayed next to the number, the up/down button will increase the number. To decrease the number, press on the Return button. Now -C is displayed next to the number and pressing the up/down button will decrease the number.
- Hold the Return button for 3 seconds to enter the address
- Push the up/down button 6 times to the menu "End".
- Push the return button to end the programming.

## 14 Configuration of IO module R560

The ClimaCheck module R560 has 8 configurable inputs, this section explains how to change Modbus address and configuration between 4-20mA and V/PT input. In most cases the IO modules will be delivered pre-configured to fit the system, but changes in the setup compared to the order may cause a need for change of these settings.

### 14.1 Change Modbus address

Modbus address is set with DIP switches marked ADR on the top left side of the unit, see Figure 8. Address is entered as a binary where DIP8 = bit 0, switches increase their bit weight from right to left. Default address for module 1 is 00010100 (20), module 2 is 00010101 (21) and so on.

RS485 bus termination is activated with the BUS END switch. The last device in the Modbus chain should have BUS END on.



Figure 8 - R560 module

### 14.2 Change Analog input mode

DIP switches for the analog inputs can be found in between the AI terminals on the bottom side of the device. Default setting is 0-10V and PT1000 (DIP switch 1-8 OFF). In this mode each input is configured on the ClimaCheck Online server. For current measurement (0-20mA) the particular DIP switch is changed to ON.

## 15 Troubleshooting

Working with measurement and validation requires special care. If inputs are wrong and left undetected, wrong conclusions are drawn from the analysed results. ClimaCheck method offers very good opportunities to cross reference and check values and results to avoid this situation.

A methodical approach is recommended in everything related to measurement and validation. The first step is to keep measuring equipment in good order and check and replace sensors deviating from specified accuracy, contacts showing signs of wear and/or damage, as well as cables showing any signs of wear and/or damage.

It is advisable to have spare sensors and cables available during installation and troubleshooting as the cost of going back and forth to pick up spares is higher than having spares available.

During commissioning, inputs should be checked one at a time to be logical and, whenever possible, cross checked with meters and sensor on site, in controls and monitoring systems. Any deviation should be checked and explained. Sensor errors in controls can be an important factor to control issues and should be documented.

ClimaCheck sensors are high accuracy (higher accuracy than standard sensors in the industry) and they should not require calibration to stay within specified acceptable accuracy. But if so desired and careful calibration is done it is possible to set an offset in equipment and/or online/software.

### 15.1 Pressure readings

All pressure transmitters undergo a quality check before shipment. If the pressure reading is outside the range, follow the below steps for troubleshooting.

#### 15.1.1 Required tools and spare parts

A multimeter with voltage and resistance capability as well as a Schrader replacement tool may be required during troubleshooting.

The recommended spare parts are pressure sensor, cable for pressure sensor, O-ring, Schrader valve.

#### 15.1.2 Transmitter type

ClimaCheck pressure transmitters have different ranges and different output signals (1-5 V and 4-20 mA). Make sure that the specified sensor is being used.

#### 15.1.3 Supply voltage

All ClimaCheck pressure transmitters require a supply voltage of 8-28 VDC. Make sure that the supply voltage is within the range and in correct polarity.

Below is a table showing what each wire on the pressure cable represents as well as how they are connected to the pressure transmitter. Note that the photo shows the contact from top, on the sensor side.

Conn.	Wire	Cable (old)	Cable (new, 2017)
1	GND, Ground	green	black
2	+OUT, Signal	white	white
3	+VCC, Supply	brown	red
	Shield		Yellow

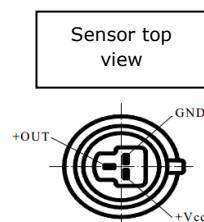

In the ClimaCheck housing:

- Disconnect the pressure cable.
- Measure the voltage between the terminals where VCC and GND are going to be connected.
- Make sure to have 8-28 VDC.
- Reconnect the pressure cable.

On the sensor end of the pressure cable:

- Disconnect the sensor.
- Measure the voltage between pins 3 and 1 on the pressure cable. A small piece of wire may be needed to access the pins.
- Make sure to have 8-28 VDC.
- If the specified voltage is not measured, change the pressure cable and check again.
- Reconnect the sensor.

#### 15.1.4 Pressure signal

It is possible to measure the voltage signal output of the transmitter in order to determine if the transmitter needs to be changed.

Below is a table showing the output voltage for each transmitter type, when measuring atmospheric pressure, as well as the scale and offset of each transmitter type.

Transmitter types	Voltage at 100 kPa(a)	Scale	Offset
-0.7...5 Bar(g)	1.491 V	142.5	-112.5
0...10 Bar(g)	1 V	250	-150
0...35 Bar(g)	1 V	875	-775
0...50 Bar(g)	1 V	1250	-1150
0...150 Bar(g)	1 V	3750	-3650

- Disconnect the OUT/Signal (white) wire from the terminal in the ClimaCheck housing.
- Disconnect the pressure transmitter from the valve, so that it measures the atmospheric pressure.
- Measure the voltage between the OUT/Signal wire and the terminal where the GND wire is connected.
- Check that you have the voltage specified in the table above.  
If the measured voltage does not correspond to the values above, change the pressure transmitter and measure again.
- Reconnect the transmitter to the valve, so that it measures the refrigerant pressure.
- Measure the voltage between the OUT/Signal wire and the terminal where the GND wire is connected.
- The measured voltage can be used to calculate the pressure:  
$$\text{Pressure (kPa(a))} = \text{Voltage} \times \text{Scale} + \text{Offset}$$
- Reconnect the OUT/Signal wire to the terminal in the ClimaCheck housing.  
If the calculated pressure does not correspond to the reading in the PA Pro, the configuration in the PA Pro needs to be checked. Contact ClimaCheck support for more help.

### 15.2 Temperature readings with PT1000 sensors

All PT1000 temperature sensors undergo a quality check before shipment. If the temperature reading is outside the range, follow the below steps for troubleshooting.

#### 15.2.1 Required tools and spare parts

An ohmmeter may be required during troubleshooting.

It is recommended to have a spare PT1000 sensor.



### 15.2.2 Common issues

Common issues with PT1000 sensors and corresponding solutions are listed below:

- *The channel on the PA Pro shows around 150 °C*  
The terminal is open, meaning there is no sensor connected to that channel.  
Make sure the wires are connected well.  
Test a spare PT1000 if needed.
  
- *The channel on the PA Pro shows around -50 °C*  
There is a short circuit on the terminal.  
If using a 4-lead wire, make sure that the leads with same colour are connected together.  
Test a spare PT1000 if needed.
  
- *All channels of the R560 show around 0 °C*  
There is no Modbus communication between the R560 and the PA Pro.  
Refer to the wiring diagram and make sure that the RS485 wires are connected properly.

### 15.2.3 Temperature-resistance table

It is possible to measure the resistance of the PT1000 sensor in order to determine the measured temperature. Disconnect the temperature sensor from the terminal, measure the resistance between the leads, and check the table below. If using a 4-lead wire, the leads with the same colour are connected together.

Temperature (°C)	Resistance (Ω)
-50.00	803.0906
-40.00	842.7287
-30.00	882.2332
-20.00	921.6101
-10.00	960.8643
0.00	1000
10.00	1039.02
20.00	1077.927
30.00	1116.721
40.00	1155.402

Temperature (°C)	Resistance (Ω)
50.00	1193.97
60.00	1232.422
70.00	1270.756
80.00	1308.967
90.00	1347.05
100.00	1385
110.00	1422.809
120.00	1460.47
130.00	1497.972
140.00	1535.307
150.00	1572.463

### 15.3 Temperature readings with 1-wire sensors

All 1-wire temperature sensors undergo a quality check before shipment. Common issues with 1-wire sensors and corresponding solutions are listed below:

- *"No temp sensors or conn. Wrong. OK?" is showed while configuring sensors.*  
Check wiring and make sure all sensors are connected properly (Data, GND). If the wires from one (1) sensor are mixed up the whole 1-wire bus stops.
  
- *"No new s-r found" is showed when trying to connect/configure sensor.*  
Check wiring, topology and weight of the 1-Wire bus and make sure sensor is not already connected/configured on a different position.
  
- *Sensors has been connected/configured on the wrong position*  
Contact ClimaCheck support with a revised connection list or Clear all configured sensors and connect them again. Check section 10 for more info.

- *A configured 1-wire sensor is showing -999.99°C*  
PA Pro III has lost connection with the sensor. Check wiring, topology and weight of the 1-wire bus. Check section 10 for more info.

## **15.4 Power measurement**

In case of trouble with the power measurement, please refer to the suggested actions described in this section.

### **15.4.1 Supply voltage**

If the power meter display does not light up, then there is no adequate voltage supply to the power meter.

Note that the EM24 is powered from the main housing voltage supply, and the EM210 is powered from the measured voltage on phases L2 and L3.

### **15.4.2 Communication**

If the power meter displays measured values but the PA Pro does not show any data:

- Check that the RS485 cables are connected as shown on the provided wiring diagram, both on the power meter and the PA Pro. Make sure that they are connected tightly.
- Check that the Modbus address is correct and the baudrate is set to 9600. Follow sections 12.2 and 13.2 for more details.
- Make sure that there is adequate voltage supply to the power meter. The unit may be powered on, but the Modbus communication will not function properly without correct voltage supply.
- Make sure that the PA Pro configuration is set correctly. Contact ClimaCheck support for more help.

### **15.4.3 Measurement**

Experience shows that the biggest challenge for ClimaCheck users is to apply power measurements correctly. Outmost care is recommended when applying sensors as it can often be difficult to follow cables in confined housings.

Always compare measured currents and power with rating plates and/or nominal data at start of measurements.

Make sure that the CT configuration is set correctly on the power meter. Check section 5 for more details.

Check the following on the power meter display:

- **Current**  
If current is unbalanced, check that clamps are fully closed. If wrong level, check CT configuration and make sure that the complete compressor current and only compressor current is measured. Typically, current per phase is not allowed to vary so that any phase deviate more than 10% from the average for a three-phase motor.
- **Voltage**  
Typically, voltage per phase is not allowed to vary so that any phase deviate more than 10% from the average for a three-phase motor.
- **Power per phase**  
If the power is uneven check the above points about current and voltage. If any power is negative but voltage and current are correctly matched, the CT is turned in the wrong direction or wires between CT and meters are crossed.

- Power factor per phase and total  
At full load, power factor is 0.75-0.95 for three-phase motors – higher for large/high efficiency motors – but it can decrease significantly at low/part load. It is common that voltage measurement to one or several power meters is taken from one place with a fused auxiliary supply and it can be a challenge to follow cables to the point where CTs are applied, frequently a significant distance from the voltage measurement point.
- Error in power factor is typically caused by:
  - i. *Mismatching voltage and current or direction of current*  
To validate the match, if possible, measure with a multimeter in voltage position. Put one probe at the terminal in the direct vicinity of the CT and the other to the corresponding voltage input at the power meter. This voltage should be 0 V whereas if the probe is moved to another phase on the meter it should show the full line to line voltage.
  - ii. *Interference on phase shift/Power factor by influence on CT wiring from power line*  
Phase shift/Power factor values are sensitive to interference caused by power lines. Good practice for wiring of sensor leads should always be respected to avoid problems e.g. sensor cables should be separated from power cables and not run parallel to power cables without proper separators/shielding.  
If power factor is inconsistent, wiring should be inspected and separation/shielding introduced if cables can be affected by magnetic fields from power cables.  
Sensor cables can cross power lines at right angle but should not be run in parallel and never in bundles with power cables.
  - iii. *Resistance in CT cables*  
Wire resistance that cause larger “burden” than allowed for a CT will affect the phase shift/power factor. Always respect wire length and size to avoid to decrease accuracy. Typically, phase shift increase = power factor decrease with a burden above the allowed.

Check if part winding or double cables are used and not correctly measured (see section 5.1).

Ensure that only compressor power is measured (pumps/fans should not be included in compressor power). If compressor cannot be measured separately, make an offset for accessories on ClimaCheck online.

If inverters are used, it is normally necessary to measure before inverter and use a loss factor of typically 3-6% to compensate for the heat loss (inverter manufacturers can often give loss factor for their specific units). Power factor for inverters are typically close to 1. If the power factor is wrong or uneven, the phase order or the match between voltage and current are normally not correct.